

IR INFRARED INDUSTRIES



FGA4000XDS

Four and Five
Gas Analyzer

Operator's Manual

Revision 10-17-2018

© Infrared Industries
25590 Seaboard Lane
Hayward, CA 94545
Phone 800.344.0321 • 510.782.8100
www.infraredindustries.com

Table of Contents

INTRODUCTION	6
ANALYZER SET-UP	8
Power UP	8
Printer Paper Installation.....	9
SYSTEM FEATURES	10
Front Panel.....	10
REAR PANEL	11
CHAPTER 1 –	12
CONFIGURING THE ANALYZER	12
Data Capture Option:.....	12
Lower Left Window:	12
Lower Right Window:	12
Speed Option:	12
Measure Mode Option:	13
Exhaust Dilution:.....	13
Tachometer:.....	13
Serial Port Communication:	13
Time and Date:	13
Leak Check:	14
Field Calibration:.....	14
FACTORY CALIBRATION RESET:	15
GPM Measure Mode:	15
System Information:.....	16
CHAPTER 2 –	18
USING THE ANALYZER	18
Warm-up	18
Measuring Gas	19
Recording Data.....	19
Calibration.....	20
Dual Exhaust	21
Tachometer	22
Zeroing	22
Grams per Mile (Kilometer)	23
Exhaust Dilution	24
CHAPTER 3 –	26
EXHAUST GAS/EMISSION	26
Combustion Fundamentals	26
Gas Fundamentals.....	26
Oxides of Nitrogen (optional).....	27
Hydrocarbons	28
Carbon Monoxide	28
Carbon Dioxide	29
Oxygen.....	29
Conclusion.....	30
Stoichiometric Fuel Mixtures.....	30
Catalytic Converters.....	31
CHAPTER 4 –	34
TESTING	34
Using Analyzer Readings for Diagnosis	34
General Tailpipe Testing Tips	36
Vehicle Inspection.....	37
Engine Conditioning.....	38
Connecting Probe Hose to System.....	38
Interpretation.....	38
CHAPTER 5 –	40
MAINTENANCE	40

<i>Sample Hose</i>	40
<i>Filter Assembly</i>	40
<i>Front Panel and Exterior</i>	41
<i>Oxygen Sensor</i>	41
<i>NOx Sensor - Oxide of Nitrogen</i>	42
<i>Routine Cleaning</i>	42
<i>Returning the Analyzer for Service/Repairs</i>	43
CHAPTER 6 –	44
TROUBLESHOOTING	44
<i>Analyzer Troubleshooting</i>	44
APPENDIX A –	46
LAMBDA CALCULATIONS	46
<i>Brettschneider Equation</i>	46
APPENDIX B –	48
DAC OUTPUTS	48
APPENDIX C –	50
OBDII OPTION	50
APPENDIX D -	52
SPECIFICATIONS	52
<i>Principal Gases/Ranges measured</i>	52
<i>Output Data Interface:</i>	52
APPENDIX E –	54
WARRANTY	54
<i>Notice to Buyer and/or user of the analyzer:</i>	54
APPENDIX F –	56
GLOSSARY OF TERMS	56

Introduction

The analyzer allows the measurement of four or five gases in automotive exhaust. It is capable of determining volume concentrations of HC (as N-hexane), CO (carbon monoxide), CO₂ (carbon dioxide), O₂ (oxygen), and optionally NOx (nitric oxide).

Based on gas concentrations the analyzer will calculate the Air to Fuel Ratio (AFR), Lambda (λ) and Grams per Mile (GPM) or Grams per Kilometer. It will also provide a read-out for the optional Tachometer that handles up to 30,000 RPM. With this much information in one place, you can diagnose and tune any fuel-related issues while having all of the relevant information displayed in six super-bright, oversized displays.

All of the above is available as analog outputs in either 0 - 5VDC or 0 - 10VDC for interfacing to a data acquisition system.

In addition to the above you features; the analyzer can measure exhaust gases from two tail pipes and average the readings, or set up an exhaust dilution value to warn you if there are air-leaks in the exhaust system.

The analyzer is fully portable. Weighing only 9 pounds the unit is intended for use in a variety of indoor or outdoor environments. The analyzer can be plugged into standard power outlet voltages ranging from 90 VAC or 260 VAC, 50/60 Hz. You can connect the FGA4000XDS to the car battery or cigarette lighter and take it along for a drive test to see how the vehicle behaves in real driving situations. Using the internal record feature you can store the data during the drive test and playback or download the information to a POC when you return.

This section provides a description of the set-up of the analyzer. When setting up the analyzer for the first time check for any damage that may have occurred during shipment.

POWER UP

The analyzer can be operated from either AC or DC power sources. For AC connections the analyzer will accept 90 – 260 VDC. For DC the analyzer will run off 10-16VDC.

The AC power-input connection is a standard 3-wire recessed; computer-type connector. Various types of power cords may be used to connect to wall power. Each will have a different connector to be compatible with the various supply voltages and wall sockets.

Attach the power cord to the rear of the analyzer and plug the end of the cord into the appropriate power source. The 12VDC cable can be plugged into a cigarette lighter or battery for the power source. Make sure that the sample probe has been placed in an area where there is only air to be drawn into the sample line. Press the Power button to turn on the unit

In the first 5 seconds, all display segments and indicators will light in order to make sure they are functional. The front panel will then display PLEASE STAND BY while the analyzer is warming up. The warm-up times may vary depending on analyzer's internal temperature. The Zero and Pump indicators will be on during approximately 30 seconds after warm-up period. Do not attempt to flow any gases into the analyzer through the CAL port. This will severely affect the accuracy of the analyzer.

After the warm-up cycle is completed and the probe is in the tailpipe, press the MEASURE key to begin measurements.

Note: Check the flow indicator to make sure you have sufficient flow; the indicator should be all green.

Once the analyzer is warmed up, you can begin measuring gas concentrations by connecting the sampling hose/probe assembly to the inlet port located on the filter in the back of the analyzer. Insert sampling probe to a gas source or an exhaust stream. Press the Measure button [6] to begin sampling of the gases. Allow a few seconds for the gases to reach the analyzer. While in measure mode, you can hold or freeze the display values by pressing the Hold button [8] as displayed in chapter 3.

PRINTER PAPER INSTALLATION

If the analyzer was ordered with the optional embedded printer then it will be necessary at times to replenish the paper.

To install paper follow the following steps:

1. Turn the unit onto its right side.
2. Remove the access panel on the bottom of the machine. One Phillips screw secures the panel.
3. Push printer cam lock bar forward.
4. Insert paper roll with paper feeding from the top and down into the feed rollers.
5. Push paper out slot on front panel.
6. Pull cam lock to closed position.
7. Replace access panel.

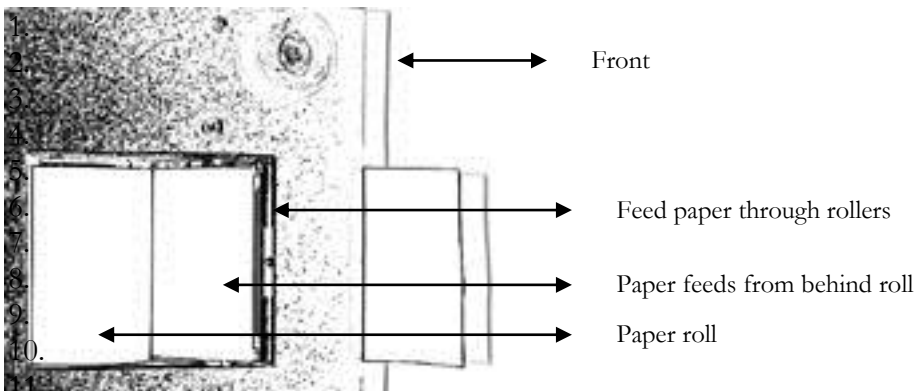
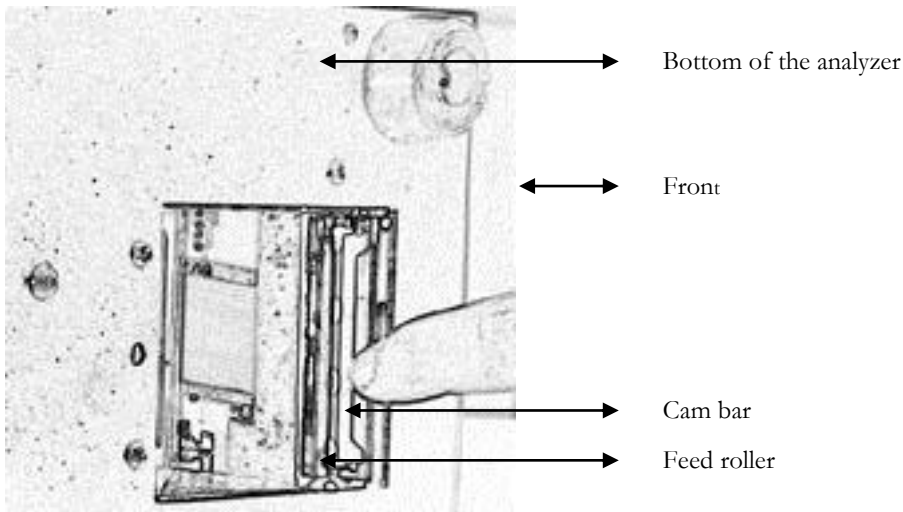

FRONT PANEL

Before attempting to operate the analyzer, review the system features described below as well as all warning labels. Identification and understanding of the physical features of the instrument will make operation easier.

FGA4000XDS front panel can display six parameters: Four fixed parameters (HC, CO, CO₂, and O₂) and any two user-selectable parameters from NO_x, AFR, RPM, and Lambda.

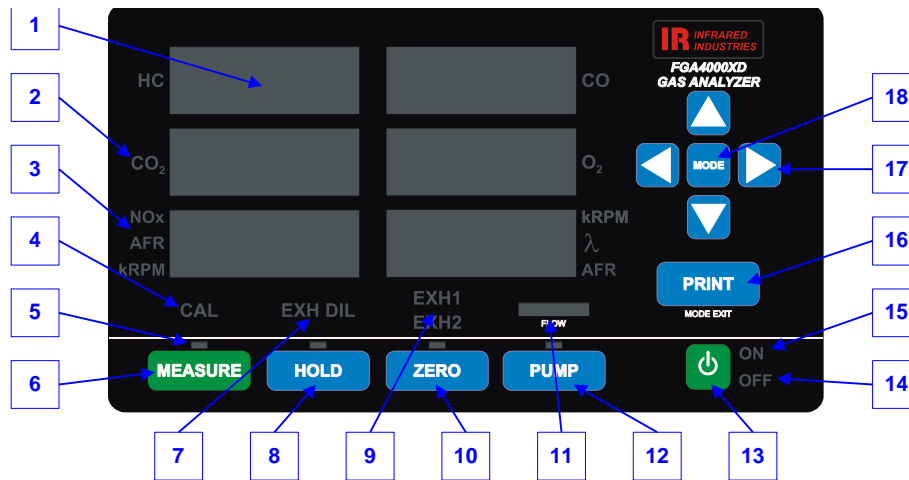

Figure 1: Front Panel

- [1] 4-Digit LED window x6.
- [2] Fixed Window Identifier x4.
- [3] User-Selectable Window Identifier x2.
- [4] Calibration Indicator. On in Calibration Mode, Blink when performing Calibration Calculation with Cal gas present.
- [5] Button Identifiers x4. On or Blink when button is selected, off when de-selected.
- [6] Measure Button. Press to begin measure mode. Pump is turned on automatically in measure mode.
- [7] Exhaust Dilution indicator. On when Dilution Mode is selected, Blink when Dilution has occurred.
- [8] Hold Button. Freezes all six-display parameters in Measure mode only. Blinks when in Hold.
- [9] Dual Exhaust Mode. Indicates which exhaust pipe the sampling probe should be in.
- [10] Zero Button. Zeros the analyzer for approx. 1 minute. Pump is automatically controlled during zero.
- [11] Flow Indicator. During pump's operation, all bars will be on. In case of a flow restriction in the gas sampling system, the bars will turn off starting from right side indicating flow restriction. In case of total restriction, the first segment will blink indicating no flow.
- [12] Pump Button. Allows manual on/off operation of the pump. Can be used to purge gas from the analyzer.
- [13] Power Button. Push momentarily to turn on the analyzer. Push & Hold for 2 seconds to turn off the analyzer.
- [14] OFF indicator. Indicates the analyzer is plugged into a power source but it is off. ON indicator. Indicates the analyzer is on and operational.
- [15] ON indicator. Indicates the analyzer is on and operational.
- [16] Print / Mode Exit button. In Measure or standby mode, the button will start the optional built-in or external printer. When in mode selection process, initiated by Mode button [18], Print / Mode exit button will terminate the mode selection and go back to standby mode.
- [17] Arrow buttons x4. Used to navigate when in Mode selection operation.
- [18] Mode Button. Enters the mode selection operation where different aspects of the analyzer can be set up or changed. Refer to the Mode Selection section for more detail

The LOW FLOW Indicator bar graph will light in the red zone when the bench accuracy of any particular gas degrades by 3% or the response time exceeds the specified time (13 seconds) because of discrepancies in the sample system i.e., clogged filters, bad pump, etc. All green segments indicate an acceptable flow. As the flow decreases, the green segments extinguish one at a time until the last one remains. At that point a red segment lights indicating flow below specifications. This will be active only when the pump is running.

REAR PANEL

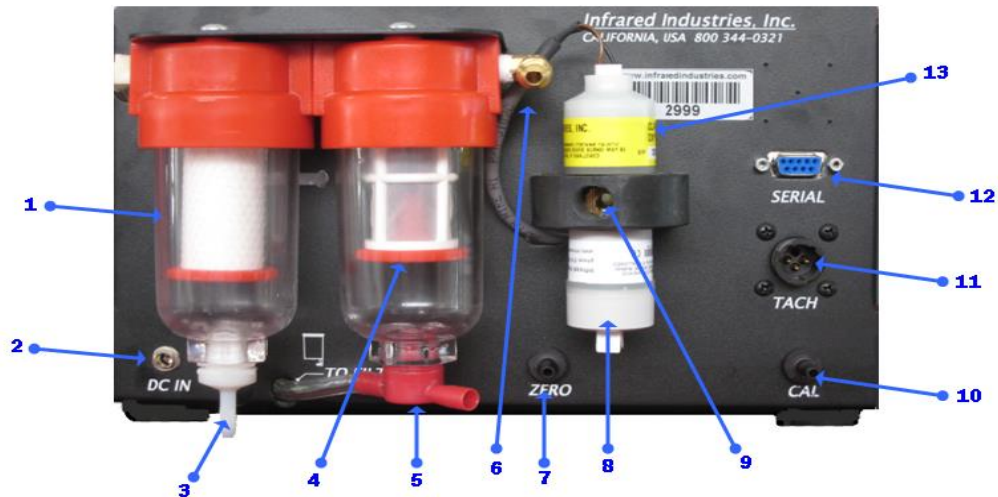

Figure 2: Rear Panel

- | | |
|--------------------------------|--------------------------------|
| [1] Paper Filter Element | [7] Zero Port |
| [2] 12 Volt DC Power Connector | [8] NOx Cell (5 gas only) |
| [3] Secondary Filter Drain | [9] Sample Gas Exhaust Port |
| [4] Water Separator Screen | [10] Calibration Port |
| [5] Aspirator/Water Purge Port | [11] TACH Connector |
| [6] Sample Hose Connector | [12] Serial Communication Port |
| | [13] O2 Cell |

Chapter 1 – Configuring the Analyzer

The FGA4000XDS has various configuration options that can be set by the operator. This chapter describes each of these options.

To enter the configuration options press the MODE button when the analyzer is in stand-by mode. Each time the MODE button is pressed the display will advance to the next option. At any time you can exit the configuration and return the analyzer to stand-by mode by pressing MODE EXIT button.

ErA	SE		
dA	tA		
	no		

DATA CAPTURE OPTION:

The analyzer has the ability to store data. If there is currently data stored in the analyzer the following display will appear. If you want to erase the data use the ▲ and ▼ buttons to select between yes and no. After you have made your selection, press MODE or MODE EXIT. If yes was selected the stored data will be erased. If no was selected the data will remain and any further data capturing that is done will be appended to the end of the stored data.

rEc	ord		
dA	tA		
	no		

The next display to appear lets you select whether or not to record data. Use the ▲ and ▼ buttons to select between yes and no. If yes is selected then when the analyzer is placed in Measure Mode the data will be displayed and captured into memory. When Measure Mode is exited the recording will stop. Each time Measure Mode is entered the data will be appended to the end of the stored data. Each time the analyzer is powered-up the default setting for this option is no.

SEL	Ect		
dISP	LAY		
NOx AFR kRPM			λ

LOWER LEFT WINDOW:

Use the ▲ and ▼ buttons to move between the choices. As a choice is selected the symbol will flash next to the window. You can select between displaying NOx, AFR (Air Fuel Ratio) and RPM (TACH). To move between the two lower windows use ◀ and ▶ buttons. When you have finished the selections you can exit the setup mode by pressing MODE EXIT or go to the next setup item by pressing MODE.

SEL	Ect		
dISP	LAY		
AFR			kRPM λ AFR

LOWER RIGHT WINDOW:

Use the ▲ and ▼ buttons to move between the choices. As a choice is selected the symbol will flash next to the window. You can select between displaying RPM (TACH), λ (Lambda) and AFR (Air Fuel Ration). To move between the two lower windows use ◀ and ▶ buttons. When you have finished the selections you can exit the setup mode by pressing MODE EXIT or go to the next setup item by pressing MODE.

FAST	Mode		
	no		

SPEED OPTION:

This option allows the response speed of the analyzer to be adjusted. For a BAR certified system the analyzer should NOT be run in fast mode. Use ▲ or ▼ to select between yes and no.

SEL	Ect		
dISP	Unit		
	conc		

MEASURE MODE OPTION:

This option selects the operation mode when the MEASURE button is pressed (placed in Measure Mode). You can select to display concentrations, perform Dual Mode measurements or perform a GPM test. Use ▲ or ▼ to select between conc (gas concentrations), gpm (grams per mile) and dual exhaust (dual) measure modes. The mode selected here determines how the analyzer will respond when the MEASURE button is selected.

In “conc” (concentration) mode the analyzer will display the various gas concentrations being measured through the analyzer.

In “dual” mode the analyzer will measure the right and left exhaust and average the results.

In “GPM” mode the analyzer will measure the gas concentrations over fixed amount of time and based on the distance traveled will compute and display the grams per mile (or kilometer) used.

In “test” mode the analyzer will compare the gas readings to limits configured into the analyzer. During a print a pass/fail indicator will be printed. Pass indicates the gas readings are within the limits configured, otherwise a fail condition is printed. When measure mode is entered the analyzer will prompt the operator for the year of the vehicle being measured.

EXHA	USE		
dILU	tIon		
	no		

EXHAUST DILUTION:

The EXHAUST DILUTION function provides the operator with a warning in the MEASURE mode that the probe may not be positioned properly or that there may be a leak in the exhaust system of the vehicle. To enable this function, select YES using the ▲ and ▼ buttons.

tAch			
Stro	HES		
	2		

TACHOMETER:

This menu screen allows the operator to select between a 2-cycle and 4-cycle engine. Use the ▲ and ▼ arrows to select between 2 (cycle) and 4 (cycle).

SEr	IAL		
Po	rt		
	Pc		

SERIAL PORT COMMUNICATION:

This option defines what is connected to the serial port. The choices are a PC, printer as an external printer or OBD2 Bluetooth adapter.

SEt	dAtE		
And	tImE		
	no		

TIME AND DATE:

When a printer is connected to the analyzer the date and time is printed on the printouts. To set the date and time use the ▲ and ▼ buttons to select between yes and no. If yes is selected, then when the analyzer is placed in Measure Mode the data will be displayed and captured into memory. When Measure Mode is exited the recording will stop. Each time Measure Mode is entered the data will be appended to the end of the stored data. Each time the analyzer is powered-up the default setting for the option is no.

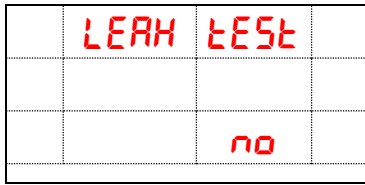

LEAK CHECK:

This option will run a leak check of the system when YES is selected. Use ▲ or ▼ to select between yes and no.

To run the test select YES and place the red cap on the end of the probe. When ready to run the test press MODE.

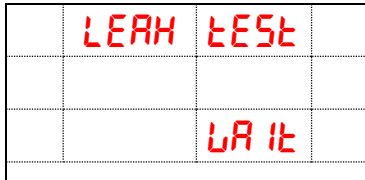

During the test this screen will be displayed. When the test is complete PASSED, BAD PUMP OR FAILED will display in the lower two windows. Press MODE or MODE EXIT to exit the test.

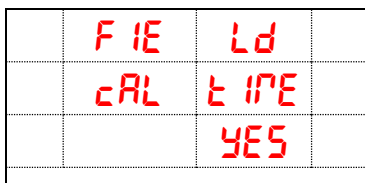

FIELD CALIBRATION:

Use ▼ or ▲ to select between yes and no. When you have finished your selection you can exit the setup mode by pressing MODE EXIT or go to the next calibration step by pressing MODE.

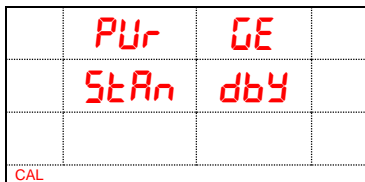

This window is displayed as the system purges the gas lines. When the purge is complete the next screen appears:

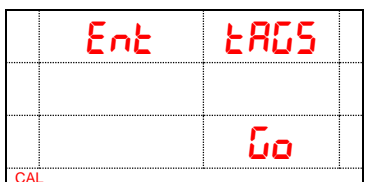

This window is prompting you that the next step will be to enter your tag values. If you want to proceed with the calibration setup, press MODE. Otherwise, if you would like to exit without calibrating, press MODE EXIT. **If you want to reset the analyzer to the factory default, setting press MODE EXIT. See Factory Calibration Reset below.**

The tag values should be entered just as they are on the calibration bottle. You are not required to calculate HC using the PEF value. Instead enter the propane value and the analyzer will internally convert it to HC. When tag values for CO and CO2 are entered they are entered as percentages. For HC and NOX values they are entered as ppm. Any gas you do not want to calibrate should be left with a value of zero. O2 does not get calibrated.

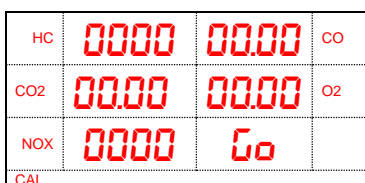

Use ▲ and ▼ to change the number that is currently flashing. To move to another digit or field use the ◀ or ▶ button. You can move to the next window by pressing the MODE button. After entering the tag values press the MODE button until the Go in the lower right window flashes. If you want to proceed with the calibration press MODE otherwise if you would like to exit without calibrating press MODE EXIT. If you proceed with the calibration the next screen will appear with the Go flashing.

	TURN	CAL	
	GAS	on	
		Go	
CAL			

At this point you must turn on your calibration gas. When the gas is on press MODE otherwise once again you can exit the calibration by pressing MODE EXIT.

HC	0000	0000	CO
CO2	00.00	0000	O2
NOX	0000	Go	
CAL			

This window will now display the current concentration values for the gases. By watching this window you can see when the gas is stabilized within the analyzer. The Go will flash to indicate that you must press MODE for the calibration to begin. When you press the MODE the CAL enunciator will begin flashing and the lower right window will go blank. This tells you calibration is in process. When the calibration is complete you will see:

	TURN	OFF	
	CAL	GAS	
		Go	
CAL			

Once again the Go will flash indicating you must press MODE. You have now completed the calibration process and the analyzer will do a purge and return to a standby state.

FACTORY CALIBRATION RESET:

At any time during the calibration when the analyzer is waiting for input from the operator, the MODE EXIT button can be selected to abort the calibration. At this point the analyzer will display:

	RESET	to	
	FACTORY	or	
		YES	

Use ▼ or ▲ to select between yes and no. If you select yes the analyzer will reset to the calibration values used at the time it left the factory. If you select no the analyzer will leave the calibration values as they were before the calibration was started.

GPM MEASURE MODE:

In the Measure Mode Options when GPM is selected the analyzer will compute grams per mile (or kilometer) when the analyzer is put in Measure Mode (by pressing the MEASURE button). Once in measure mode the analyzer will display:

	GPM	TEST	
	odometer	0000	
	Liter	0000	

The Measure light will start flashing. In the middle right window the starting odometer reading should be entered (truncating off the mileage over 1000). This can be in units of miles or kilometers depending if you want to measure Grams per Mile or Grams per Kilometer. In the lower right window the engine displacement should be entered. To set both values use ▲ and ▼ to change the number that is currently flashing. To move to another digit or field use the ◀ or ▶ button. You can move to the next window by pressing the MODE button.

When both values have been entered press the MEASURE button to start the measurement. A counter will appear in the lower right window showing the number of seconds the test has run. During this time the car should be run through the test procedure for IM240, or any other test procedure defined by your area. The analyzer does not make any assumptions about the test being run.

When you have completed the test course press the MEASURE button again to end the measurement. The display will show:

	GPM	done	
	odor	0000	
	Liter	0000	

At this point enter the ending odometer reading from the vehicle. When the value is entered press the MEASURE button again. The display will now show the computed values for GPM.

NOTE:

If the DAC Option is present, the readings on the DAC pins will show changes while the test is in progress.

HC	0.000	0.00	CO
CO2	0.0	---	
	---	---	

When you have finished reading the number the analyzer can be put back in standby mode by pressing the MEASURE button one more time.

SYSTEM INFORMATION:

In Standby Mode you can retrieve information about the analyzer by pressing the ▼ button and holding for 5 seconds.

The screen will display:

	PEF	0.521	
	PrES	768.2	
	TEMP	33.81	

The first line is the PEF value.
 The second line is the current pressure in the sample cell.
 The third line is the current ambient temperature (Celsius).

By pressing MODE a second screen of information will appear:

	vEr	4.10	
	65n	1234	
	55n	5678	

The first line is the current version of software installed in the system.
 The second line is the bench serial number.
 The third line is the serial number of the analyzer.

Pressing the MODE button will toggle between the two screens of information.

To return to Standby mode press MODE EXIT.

Chapter 2 – Using the Analyzer

WARM-UP

PRE-WARM-UP LOCKOUT PHASE

The system enters the PRE-WARM-UP LOCKOUT phase when power is first applied by pressing the POWER ON/OFF switch (main front panel). The system goes into this state for five minutes. During PRE-WARM-UP LOCKOUT, the system turns on all the display segments and indicators. All the digital displays show 8888, the decimal points and all the indicators are lit. This is referred to as LAMP TEST. The operator should use this phase to ensure that all lights and display segments are functional. Inoperative display segments can easily lead to inaccurate visual readings. The pump runs during this phase to purge any residual gases from the sample hose. **During this phase the operator should have the probe exposed to ambient air and should not be near any exhaust.** No other modes of operation can be initiated during this phase.

After the PRE-WARM-UP LOCKOUT phase, five-minute time period expires, the unit goes into the WARM-UP OPERATE phase. The first function in this phase is an Auto Zero. After the auto zero, the system tests itself. If the system is stable, it will leave the WARM-UP OPERATE phase and move to STANDBY mode. If the stability test indicates that the system requires more warm-up time, the system will enter the WARM-UP OPERATE phase.

In the STAND-BY OPERATE mode of the WARM-UP phase, the system will allow the operator to initiate a measurement. A measurement is initiated in the normal fashion. The system will make the measurement in this mode, and may be at full accuracy.

In the STAND-BY mode, the operator will also be able to turn the pump on and off by the use of the PUMP switch. The pump can be used normally in this mode to purge the gas from the probe or any other purpose.

In the STAND-BY mode the operator will be able to enter AUTOZERO mode.

If the operator does not initiate any of the functions allowed in the WARM-UP OPERATE phase, the system will wait for five minutes, auto-zero itself, and test again for stability. If the system is stable at the end of that time the system will move into STANDBY mode. If the system is still not stable, the system will remain in the WARM-UP OPERATE phase, and begin to wait for another five minutes. If during the WARM-UP OPERATE phase the operator initiates an allowable operation, the five-minute time period will be restarted when the allowable operation is complete.

The WARM-UP OPERATE phase allows measurements to be made quickly after power-up and only slightly outside the specified accuracy limits of a fully warmed up unit.

MEASURING GAS

MEASURE INITIATION

Pressing the MEASURE push button will start the MEASURE sequence. The first push of the MEASURE push button lights the MEASURE indicator, takes the analyzer out of the STANDBY mode and puts it in the MEASURE mode. The operator can tell the system in a MEASURE sequence because the MEASURE indicator is on.

MEASURING

In the MEASURE mode, the analyzer turns on the pump drawing in the sample gas from the probe into the analyzer. The analyzer then measures the sample gas and reports these reading to the display. During the same process the analyzer will calculate the AFR and LAMBDA values are then reported to the display. While in the MEASURE mode the analyzer will lockout the PUMP and ZERO keys on the display and the MEASURE indicator will be illuminated on the display.

FREEZE DISPLAYS

If it is desired to freeze the readings in the MEASURE mode, press the HOLD push button while in the MEASURE mode. This will freeze the display and the concentration values will not be updated while the displays are frozen. Pushing the HOLD push button while the display is frozen will deactivate this feature.

PRINTER OPTION

Full systems can be ordered with the internal printer option. The printout will represent the display values that the system measures and calculates at the instant the PRINT button is depressed.

RECORDING DATA

In the MODE menu it will give you the option to record data. If you select YES when the analyzer is placed in MEASURE mode, data will be recorded. In the SLOW mode 16 minutes of data can be recorded. In the FAST mode 8 minutes of data can be recorded. Each time the analyzer cycles power, the record data option will reset to NO.

After you are done with the MEASURE mode and the analyzer is in standby, you can replay the data by selecting the right arrow key. When recorded data is being displayed, the LEDs on the front panel will be dimmer than normal. The data can also be uploaded to the PC.

To erase the data from the analyzer, select MODE and this time a menu item will appear asking if you want to erase the data. You can select YES or NO.

CALIBRATION

The analyzer as shipped has been calibrated at the factory and is designed to maintain calibration accuracy for extended periods of operation. Due to the sophisticated circuitry used in the analyzer, frequent calibration is not required. However, we recommend a gas calibration about every six months to ensure the integrity of the analyzer. Some states have regulations governing the time intervals between calibrations. It is important to comply with the governing regulations for your locality.

NOTE: When using calibration gas, the bottle should be kept at about 21°C [70°F] for 8 hours prior to use. Sudden temperature changes can condense some of the components in the bottle, changing their concentration.

CALIBRATION GAS AND REGULATOR

A bottle of calibration gas is required to check analyzer calibration and to perform calibration. For the high-pressure cylinders of gas, a regulator is needed to monitor the pressure of the calibration gas bottle and to regulate it to the pressure required for testing and calibration. An output pressure to the analyzer of 2~4 psi is all that is needed to perform a calibration. The key to a good calibration is to wait for the reading of the calibration gas on the analyzer to stabilize before progressing on to the next step.

Calibration gas has a known concentration of HC, CO, and CO₂. The gas is available in a range of concentrations. We recommend using calibration gas of the following concentrations when checking or calibrating the FGA4000XDS Gas Analyzer

For a 4-Gas Analyzer use BAR90 Mid or:

- HC (propane) - 1500ppm
- CO₂ - 12%
- CO 4%
- Balance N₂
-

For a 5-Gas Analyzer use BAR97 High or:

- HC (propane) – 3000ppm
- CO₂ – 12%
- CO – 8%
- NOX – 3000ppm
- Balance N₂

NOTE: We list balance N₂ here because we recommend that O₂ be calibrated using air during AUTO-ZERO.

If you choose to use cal gas with different concentrations, it must be within the following ranges:

- HC (propane) 140 ppm to 3400 ppm
- CO₂ 5% to 15%
- CO 0.9% to 8.5%

FIELD CALIBRATION WITH CERTIFIED CAL GAS

The analyzer does not need regular field calibration. However, field calibration can be performed when there is reason to believe that the factory calibration is no longer producing accurate analysis results.

The gas analyzer does not require gas calibration very often. Therefore the gas calibration tanks are normally closed. It will be assumed in the calibration process described below that the calibration gas is turned off at the tank.

CAUTION: WHEN CALIBRATING OXYGEN WITH CAL GAS (other than ambient air), THE INTERVALS BETWEEN CALIBRATIONS FOR THE OXYGEN SENSOR WILL BE CONSIDERABLY FURTHER APART - DAYS, WEEKS, OR MONTHS DEPENDING ON HOW OFTEN THE UNIT IS GAS CALIBRATED, AS COMPARED TO THE AUTO ZERO CYCLE PERIODS (MINUTES). BECAUSE THE ANALYZER IS INHERENTLY SPAN STABLE, IT IS BEST IF THE OXYGEN SENSOR IS ALLOWED TO SELF CALIBRATE AUTOMATICALLY ON AMBIENT AIR DURING THE AUTO ZERO CYCLE RATHER THAN TO USE CAL GAS.

NOTE: The oxygen sensor and circuitry do not need calibration; they are checked automatically during zeroing. If the sensor deteriorates to the point of needing replacement, a Zero Failure may occur after zeroing.

To calibrate the analyzer press the Mode button [18] repeatedly until you see FIELD CAL NO appear on the screen. Press the Up arrow button once to select YES and then press MODE. The CAL indicator [4] will be on and the analyzer will enter a purge and zero sequence. Please wait until you see ENTR TAGS GO. Press the MODE button [18] and begin entering the Tag values in each of the windows. For HC enter the actual propane tag value. The Machine will automatically use the correct PEF ratio. Use the UP or DOWN arrow keys to increment or decrement each digit and Left or Right arrows to move to individual digits. Press the MODE button [18] to advance to the next window. Enter all zeros if do not wish to calibrate a particular gas. We recommend always entering all zeros in the O2 window. By pressing the MODE button after entering the last tag value, you will see the message: TURN CAL GAS ON GO Make sure the Cal Gas is connected to the CAL port in the back of the unit. The CAL port is located in the bottom right of the back panel. Turn on the calibration gas and press the MODE button. You will see the concentrations changing on the display. Wait until all the values have stabilized; this may take a few seconds. When the values have stabilized, press the MODE button [18]. The CAL indicator will be blinking. Do not disturb the gas flow at this point. When the CAL indicator turns off, you will see the message: TURN CAL GAS OFF GO. Turn off the Cal Gas, disconnect the hose from the CAL port, and press the Mode button. Within a minute the analyzer will purge the Cal Gas and re-zero itself. The Field Calibration will then be complete.

DUAL EXHAUST

DUAL EXHAUST is a sub mode of the MEASURE mode. In this mode the right and left exhaust measurements will be averaged. When the MEASURE key is selected the EXH1 indicator will light. Insert the probe into the first of the two tailpipes.

After the reading stabilizes, press the MEASURE key. This will store the first reading in memory and light the EXH2 indicator signaling the operator to move the sample probe to the second tailpipe. After this reading stabilizes, press the MEASURE key again. At this point both EXH1 & EXH2 indicators will come on steady and the displays will show the average of the two exhaust pipe readings.

Pressing the HOLD key at this time will toggle between the EXHAUST 1 reading, the EXHAUST 2 reading or the average of the two exhaust readings up until the time the displays are released from this mode by pressing the MEASURE key again. The unit will then revert back to the STANDBY mode.

TACHOMETER

This menu screen allows the operator to select between a 2-cycle and 4-cycle engine. This option is required because *most* 4-cycle ignition engines fire only on the compression stroke or every other crankshaft revolution. 2-cycle engines fire with each revolution of the crankshaft so if your analyzer was set on 4-stroke (cycle) while measuring a 2-cycle engine; your analyzer would display $\frac{1}{2}$ your actual engine RPM. The same problem would occur if you had your analyzer set to 2-stroke while measuring a 4-cycle engine only in this case the analyzer would display 2X or twice the actual engine RPM. Engine equipped with DIS (Distributor-less Ignition System) along with some 4-cycle ignitions due fire on the exhaust stroke. In these cases an accurate RPM reading can be achieved by simply setting the analyzer to “2-stroke”.

ZEROING

AUTOMATIC AUTO-ZERO

After power-up and the WARM-UP LOCKOUT phase has been completed, the unit will begin operating. The system will use a graduated AUTO ZERO timing cycle in order to automatically initiate AUTO-ZERO cycles. As we have seen above various operating modes may initiate an auto zero cycle. The system does not include these as being a part of the AUTO-ZERO automatic cycle. The system does an AUTO-ZERO every time the system enters STANDBY, (i.e. leaves a mode). After this AUTO-ZERO cycle the automatic cycle timing continues until the system leaves STANDBY. The time period is normally fixed at about 10 minutes, but the ambient temperature affects the technical requirement for an AUTO-ZERO cycle. Therefore the system varies the time in between AUTO-ZERO cycles based on the ambient temperature and the changes in ambient temperature.

MANUAL AUTO-ZERO

The operator may initiate an auto-zero cycle any time the system is in STANDBY. If the operator pushes the ZERO push button when the system is in CAL mode (the CAL indicator is ON), the AUTO-ZERO indicator will flash to indicate that this may well be a bad time to zero the system (because in MEASURE mode the cell is likely to have gas other than air in it).

AUTO-ZERO SEQUENCE

In the AUTO ZERO mode:

- The sample pump is turned on
- The SAMPLE/ZERO solenoid is switched to the ZERO GAS and the sample cell is purged completely
- The system acquires and stores new zero data

During this process the ZERO indicator light is on continuously. The AUTO ZERO cycles last about 25 seconds.

GRAMS PER MILE (KILOMETER)

GPM is a sub mode of the MEASURE mode and implements an approximation to the IM240 tests. In this mode you will be prompted to enter the beginning odometer reading and engine displacements (in liters). Once this information is entered the test begins and the IM240 driving pattern is driven or simulated on a dynamometer. After the test is complete the ending odometer reading is entered and the test results are displayed in grams per mile (or kilometer). See Appendix C for details on this option.

About 30 states presently require smog checks of vehicles and, of these, only about 7 require in IM240 tests. The IM240 test uses a dynamometer in a varying driving pattern, and gives the results in grams per mile (kilometer). The IM240 driving pattern lasts for 240 seconds and involves the speed changes shown in the graph below.

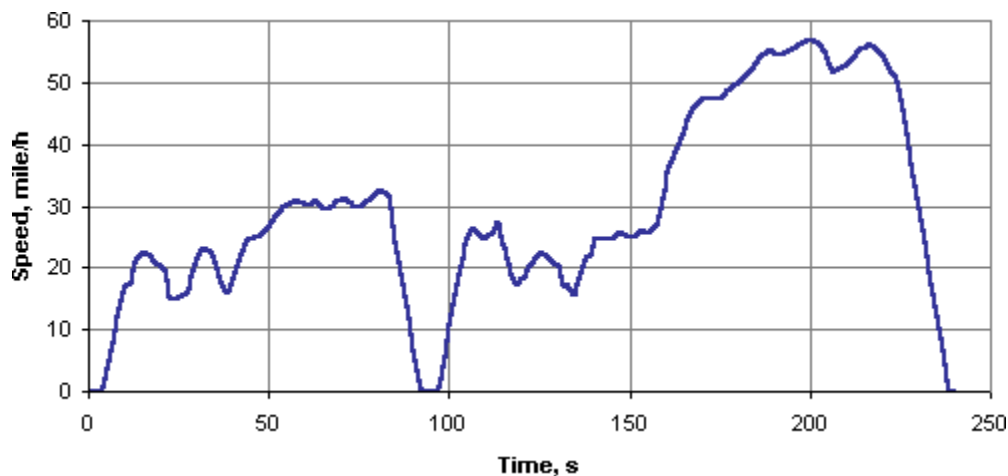

The first 94 seconds of this pattern are sometimes referred to as a **Fast-Pass** test. If all of the limits for gm/mile for the gases being tested are met during this phase, then the vehicle passes the test and the more extensive 240 second drive test is not conducted.

This driving test can be approximated without a dynamometer by conducting a road test instead and taking data using the Infrared Industries model FGA4000XDS engine gas analyzer. To perform this test, follow the steps below.

THE 94 SECOND FAST-PASS TEST APPROXIMATION

1. Position the vehicle under test (VUT) on a flat road with an uninterrupted length approximately 1 mile (or place it on a dynamometer). The VUT and catalytic converter must be up to temperature.
2. Connect the tachometer and exhaust gas inputs to the FGA4000XDS.
3. Put the FGA4000XDS in the GPM measure mode (from the stand-by mode press the MODE button until you see on the display:

SEL	Ect
dISP	LAY
	CONC

Use ▼ or ▲ to select **GPM** (grams per mile) measure modes. When selected press MODE EXIT.

Start the test by pressing the MEASURE button. The display will now prompt you to enter the starting odometer reading and the engine displacement.

GPP	Node
odo	0000
dISP	0000

Use the arrow keys (▼, ▲, ◀ and ▶) to enter the values.

1. Accelerate the VUT at a rate of approximately 3.3 mph per second for about 10 seconds or until the VUT reaches 30 mph.
2. Press the MEASURE key on the FGA4000XDS.
3. Cruise at 30 mph for approximately 10 seconds.
4. Decelerate to 0 mph.
5. Press the MEASURE key to end the test.

You will now be prompted for the ending odometer reading.

Use the arrow keys (▼, ▲, ◀ and ▶) to enter the values.

GPP	Node
odo	0000
dISP	0000

Press the MEASURE key and the final results will be displayed. At this point you may print out the results by pressing the PRINT key. When finished with the results press MEASURE to go back to stand-by mode.

EXHAUST DILUTION

The EXHAUST DILUTION function provides the operator with a warning in the MEASURE mode that the probe may not be positioned properly or that there may be a leak in the exhaust system of the vehicle. It is common to have the hose probe come out of the exhaust because the hose was kicked or for some other reason. The EXHAUST DILUTION function is meant to warn the operator that this has happened.

The warning is based on the measurement of CO₂. Typically vehicle exhaust has anywhere from 16 to 25% CO₂. If the CO₂ is ever below 12%, when it should be measuring vehicle emissions, it is most likely because the probe has fallen out. Therefore the system checks to make sure that there is at least 12% CO₂ in the gas in the sample cell when in MEASURE mode. If not, it flashes the EXHAUST DILUTION indicator.

The feature can be enabled or disabled by the operator. The default is that EXHAUST DILUTION is enabled and that the threshold is 12%.

The function is enabled and the operator has an opportunity to modify the EXHAUST DILUTION threshold, by pushing the EXHAUST DILUTION push button momentarily. The threshold for the EXHAUST DILUTION function will be displayed in the top right (CO₂) display [all other displays will be blank]. The operator can press the “↑” and “↓” push buttons and the EXHAUST DILUTION threshold will increase or decrease its value. When the operator has the value he wants to use (we recommend 12%), pressing ENTER will save the EXHAUST DILUTION threshold value and the EXHAUST DILUTION indicator will come on. The system now has EXHAUST DILUTION active.

To disable the function, when the feature is on (i.e. the EXHAUST DILUTION indicator is lit), press and hold the EXHAUST DILUTION push button for more than five (5) seconds. When the feature is disabled the EXHAUST DILUTION indicator will be turned on.

Chapter 3 – Exhaust Gas/Emission

COMBUSTION FUNDAMENTALS

To understand and interpret the information provided by the analyzer, it is helpful to have an understanding of what the analyzed combustion byproducts are, how and where they are formed in a gasoline engine, and the relationship between them at different air-fuel ratios.

In a gasoline-powered, internal combustion engine, normal combustion is the spark-ignition of a compressed mixture of hydrocarbon fuels and air, taking place in the combustion chamber. This action produces the pressure that forces the piston downward. Figure 4 shows the compressed air-fuel mixture being ignited by the spark plug.

The fuel induction system of a gasoline engine forms air-fuel mixtures by vaporizing gasoline (a hydrocarbon), and mixing it with air in a given proportion (always more air than gasoline vapor).

There is 14 times as much air as fuel (by weight), needed to vaporize the fuel into a state for ignition and to supply enough oxygen to the fuel so it can burn in the combustion reaction.

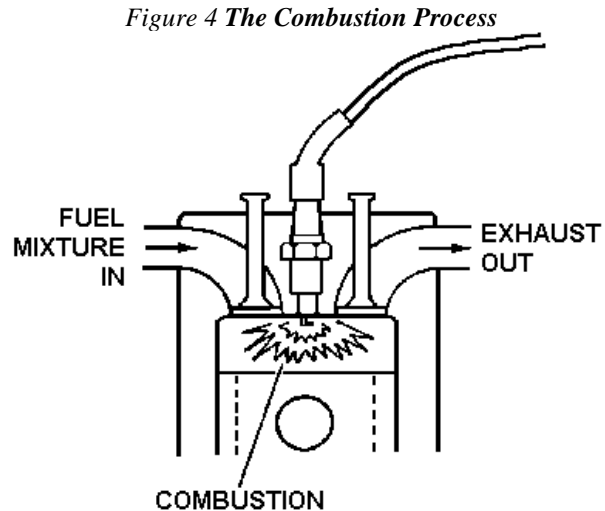

GAS FUNDAMENTALS

LAMBDA

The ideal air-fuel ratio for perfect combustion in a gasoline engine is 14.66:1, or 14.66 pounds of air to each pound of vaporized gasoline. This is known as a stoichiometric ratio or stoichiometric fuel mixture.

NOTE: Lambda (λ) is Air Fuel Ratio/14.66. This parameter is easier to use because it is 1.0 when the combustion is optimal. Lambda is less than one for “rich” combustion and greater than one for “lean” combustion. We will use Lambda in our discussion of combustion.

Under perfect conditions the combustion of a stoichiometric air-gasoline mixture would result in carbon dioxide (CO_2), water vapor (H_2O) and nitrogen (N_2), which are all harmless combustion byproducts. Therefore if we measured the exhaust of a gasoline engine and found only CO_2 , H_2O , and N_2 we could assume that the engine was operating at an optimal level. This also implies that if you measure the products of complete combustion (CO_2 , H_2O , and N_2) and the products of incomplete combustion (CO and O_2) that the Air Fuel Ratio or Lambda could be calculated from these measurements. This, in fact, is the case and the FGA 4000 series product offers an option to calculate Lambda from the gas concentrations measured. The equation used by the system to calculate Lambda is discussed in detail in Appendix C.

NOTE: Air-fuel ratios are expressed by weight, not volume. An air-fuel ratio of 12:1 (Lambda .8) is 12 pounds of air mixed with one pound of fuel.

When a fuel mixture is "lean", there is too much air and too little fuel in the air-fuel ratio. If a mixture is "rich", it has too much fuel and too little air.

Because internal combustion engines are not 100% efficient, even with ideal fuel mixtures, other substances are formed in the combustion chamber during combustion and are exhausted from the engine. The major by-products of "real-world" combustion include:

- Carbon Dioxide (CO₂)
- Carbon Monoxide (CO)
- Oxides of Nitrogen (NO_x)
- Hydrocarbons (HC)
- Oxygen (O₂)

Because the carbon monoxide, oxides of nitrogen and hydrocarbon exhaust products are related to health and environmental concerns, these emissions from automobiles are regulated by federal and state agencies.

OXIDES OF NITROGEN (OPTIONAL)

Nitrogen makes up about 78% of the air in Earth's atmosphere, and oxygen about 21%. Therefore, about 78% of the air in the combustion chamber is nitrogen. Nitrogen is inert and does not contribute to, or detract from, combustion.

Nitrogen and oxygen only combine with each other to form harmful oxides, including nitric oxide (NO) and nitrogen dioxide (NO₂), when both gaseous elements are heated above 1371°C [2500°F].

NOTE: Oxides of nitrogen (NO_x) include all the nitrogen compounds formed in an engine's combustion chamber, including nitric oxide (NO) and nitrogen dioxide (NO₂). The (x) subscript in place of numbers indicates that all nitrogen/oxygen compounds are included.

Under some engine conditions, the combustion chamber temperatures easily exceed 1371°C [2500°F], combining oxygen and nitrogen to form NO_x.

Figure 5: NO_x vs. Lambda

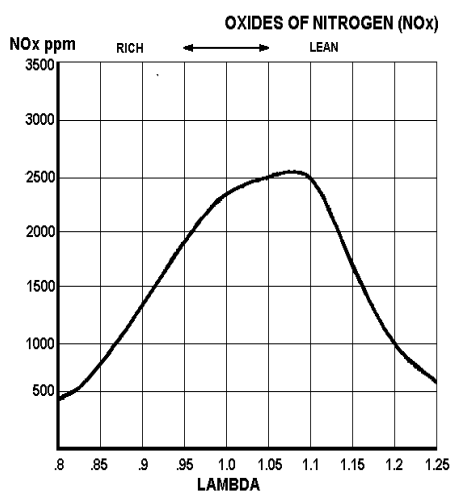

Figure 5 shows the concentration of NO_x in relation to the air-fuel ratio. When based only on air-fuel ratio, combustion chamber temperatures peak at air-fuel ratios of about 18:1 (Lambda 1.25), allowing the formation of NO_x. Since modern engines do not normally run at 18:1 (Lambda 1.25), theoretically NO_x emissions should not be a problem. However, lean air-fuel ratios are not the only cause of NO_x emissions. Moderate to heavy engine loads also cause combustion chamber temperatures to increase at ratios much richer than 18:1 (Lambda 1.25).

NO_x is not often monitored because; 1. NO_x is normally only formed when the engine is under load. Thus it would be ideal to measure NO_x while the vehicle is under load. 2. NO_x does not indicate engine performance or efficiency as does oxygen, hydrocarbons, carbon monoxide and carbon dioxide. The formation of NO_x does not affect engine performance, but some devices used to prevent it from forming can affect performance and contribute to higher levels of HC and CO if they are not functioning properly.

HYDROCARBONS

Hydrocarbons (HC) are organic compounds made up of hydrogen and carbon atoms. The HC present in gasoline engine exhaust is unburned gasoline vapor, and is measured in parts per million (PPM). HC levels in engine exhaust vary with the air-fuel ratio. Figure 6 shows the relationship of HC concentration in exhaust to air-fuel mixture.

Figure 6: HC Vs. Lambda

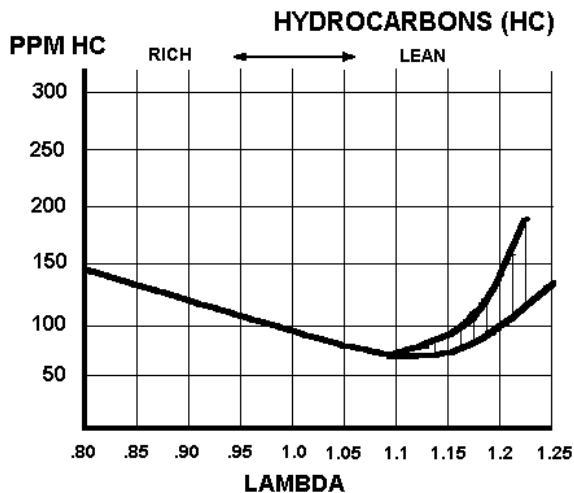

As Figure 6 shows, the lowest HC emissions occur at an air-fuel ratio of about 16.2:1. Since no engine combustion is perfect, some vaporized HC in the combustion chamber is left unburned and exits the engine with the exhaust gases. The amount of HC emissions from the engine depends to a great extent on combustion chamber design. Also, if the fuel mixture is too lean or rich to support complete combustion, or if ignition does not occur in the combustion chamber at all, HC emissions increase dramatically.

Gasoline evaporating from the carburetor and fuel tank are also sources of HC emissions, known as evaporative emissions. Vehicles built since 1970 minimize the escape of evaporative emissions.

CARBON MONOXIDE

Carbon monoxide (CO) is an exhaust byproduct formed when combustion takes place in an engine with less than an ideal volume of oxygen (rich fuel mixture), combining a carbon atom with only one oxygen atom. The carbon in the combustion chamber comes from the HC fuel, and the oxygen from the inducted air.

Figure 7 CO Vs Lambda

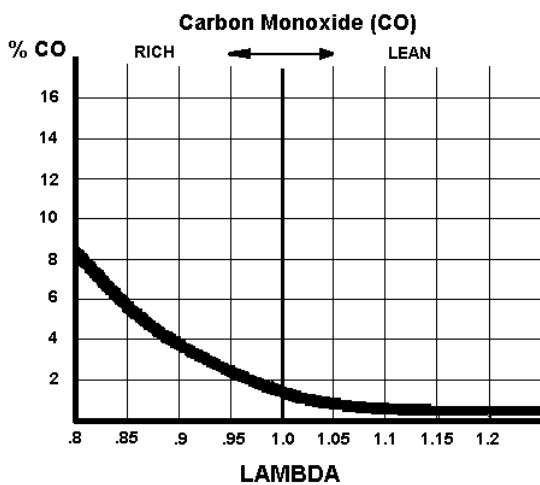

The richer the fuel mixture in the combustion chamber (more HC, less air), the higher the concentration of CO in the exhaust. Therefore, anything that causes a rich air-fuel ratio results in a high CO content in the exhaust shows the relationship between CO output and air-fuel ratio.

Figure 7 shows that the CO level decreases as the air-fuel ratio approaches about 15:1 (Lambda 1.05), and maintains this low level even while the mixture is further leaned out. Because of this, CO is a good indicator of fuel mixture richness, but a poor indicator of leanness.

This fact makes the HC and CO content in the exhaust good gauges of engine performance, in addition to their importance for Clean Air Law compliance. When HC and CO readings are compared with oxygen and carbon dioxide readings, the results can be used to indicate catalytic

converter efficiency.

CARBON DIOXIDE

Carbon dioxide (CO₂) is a combustion byproduct formed when one carbon atom bonds with two oxygen atoms (an oxygen molecule), and by the oxidation of CO in the catalytic converter. Unlike CO, CO₂ is comparatively harmless; animals give off CO₂ as a byproduct of respiration.

Figure 8 CO₂ Vs Lambda

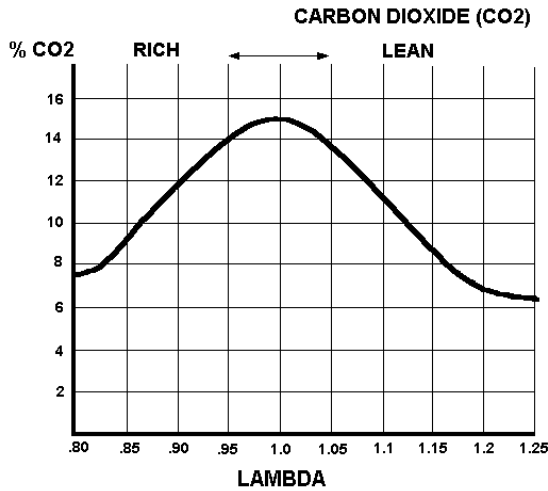

CO₂ is a good indicator of combustion efficiency because its volume in the exhaust peaks at stoichiometric air-fuel ratios. Figure 8 shows the relationship of CO₂ to the air-fuel ratio.

CO₂ peaks as the combustion chamber fuel mixture approaches about 15:1 (Lambda 1.05), and decreases when the mixture becomes leaner or richer. This fact makes CO₂ in the exhaust a good indicator of efficient combustion. CO₂ levels can also be used as an indicator of exhaust system integrity.

OXYGEN

The level of oxygen (O₂) in exhaust gas is an indicator of air-fuel ratio leanness. The O₂ originates in the air the engine inducts and mixes with the HC for combustion. Since the atmosphere is about 21% O₂, the percentage of O₂ in the exhaust gas after combustion is an indication of air-fuel ratio leanness.

Figure 9 O₂ Vs Lambda

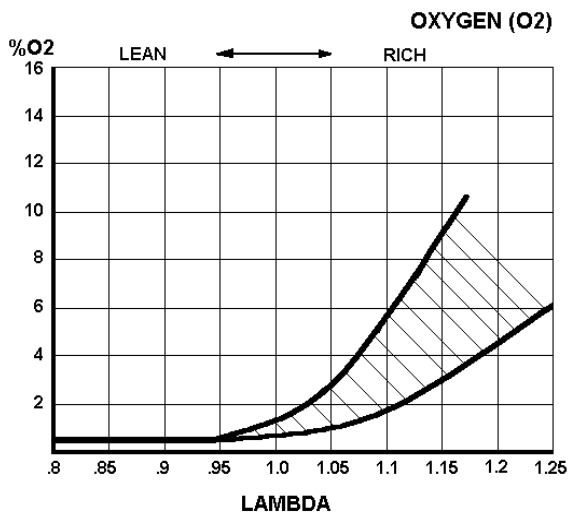

In Figure 9, the O₂ concentration is shown to be at a steady low level when the fuel mixture is richer than about 15:1 (Lambda 1.05), because all available oxygen is consumed in the combustion process. As the mixture gets leaner, the O₂ steadily increases, because less of it is used in combustion. Higher concentrations of O₂ in the exhaust are therefore directly proportional to leaner air-fuel ratios.

CONCLUSION

Figure 10 Combustion Products Vs Lambda

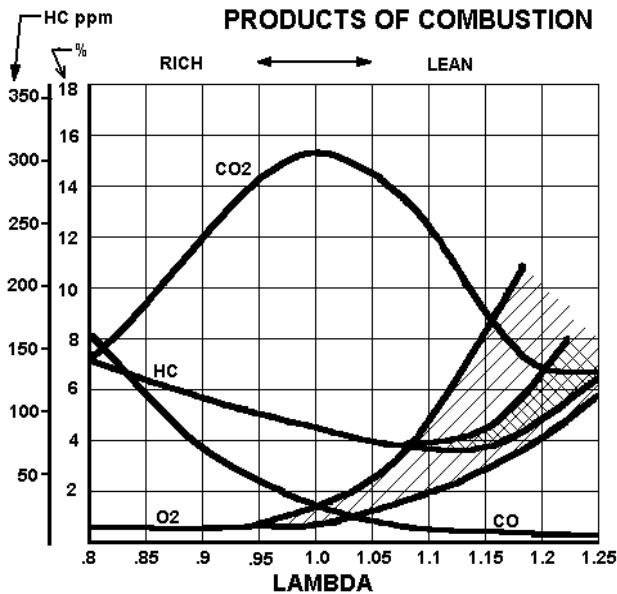

Figure 10 shows the relationship between the air-fuel ratio and the four exhaust gases monitored by the analyzer. It shows:

HC levels are lowest when the air-fuel ratio is ideal because most of the fuel is consumed in combustion. Richer or leaner mixtures or ignition problems cause the HC to increase because of incomplete combustion.

1. CO levels are lowest when the air-fuel ratio is nearly ideal because there is less oxygen and carbon left over due to the more-complete combustion occurring at ideal ratios. Richer than ideal mixtures cause CO to increase; leaner has little affect.
2. CO₂ levels are highest when air-fuel ratios are close to ideal, and decrease when the mixture becomes richer or leaner.
3. O₂ levels are near zero when the air-fuel ratio is near ideal because most of it is consumed in combustion. It remains low with richer mixtures, and increases when the mixture leans out.

STOICHIOMETRIC FUEL MIXTURES

As can be seen from Figure 11, the ideal (stoichiometric) 14.66:1 air-fuel ratio (Lambda 1.0), is near the point where the emission levels drastically change. The stoichiometric air-fuel ratio, where the HC and CO levels are lowest, is as close to perfect combustion as can be attained.

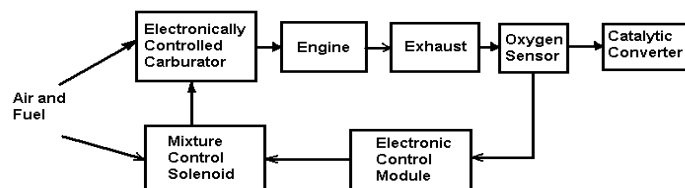
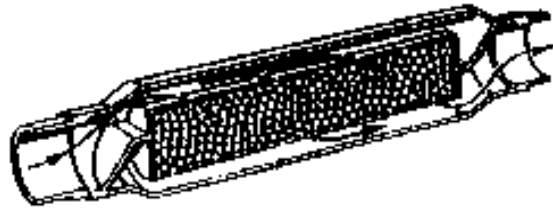

Figure 11 Carbureted Fuel Feedback System

Combustion temperatures and the air-fuel ratio requirements can change in engines under dynamic load. The only way to ensure that the air-fuel ration remains stoichiometric under most operating conditions is to use a feedback system. So modern engine computers monitor the O₂ content of the exhaust gas. The computer calculates the air-fuel ratio, and commands the fuel delivery device, either fuel injector or carburetor, to deliver the amount of fuel required to maintain the correct fuel-air ratio. A typical system is shown in Figure 11.

CATALYTIC CONVERTERS



Pellet - type

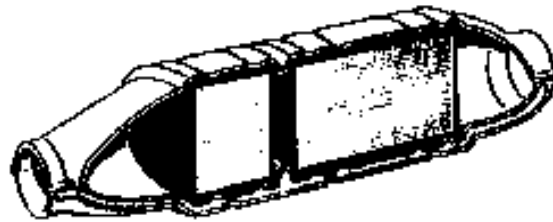

Ceramic monoliths type

Figure 12 Typical Catalytic Converters

The first attempt at reducing emission levels in automobiles was to get the air-fuel ratios as close as possible to stoichiometric. However, even engines designed for low emissions, and which are operating properly, may not have HC and CO emission levels low enough to meet Clean Air Standards. Catalytic converters are installed to further reduce emission levels.

A catalyst is a substance that increases the rate of a chemical reaction without being used up it. The catalytic converters used in automobiles contain a combination of the noble metals platinum, palladium and rhodium. These metals are applied to small beads or to ceramic baffle materials. These materials, called substrates, provide tremendous surface area for exhaust gases to come in contact with the noble metal catalysts.

Figure 12 shows the construction of two typical catalytic converters.

In operation, exhaust gases pass into the catalytic converter from the engine, where the gases flow past the catalytic metals. Contact with these metals causes reactions, known as catalytic oxidation, in the exhaust gases, adding O_2 to the molecular structure of HC and CO. This turns the HC into H_2O (water) and CO_2 (carbon dioxide). The CO is converted to CO_2 . Figure 13 shows the equations for this process.

Oxidation of any compound requires an abundance of O_2 . In most cases, engines are equipped with an auxiliary air inlet device, typically called an A.I.R. (Air Injection Reaction) pump or a pulse air system, to inject additional air into the exhaust manifold or catalytic converter, providing the oxygen needed for the reaction (oxidation) to take place. Converters of this type are called oxidation or two-way converters since they only treat two gases.

As converter technology has progressed, catalysts have been developed to treat NO_x . In this reaction, oxygen is removed from the NO_x compounds, reducing them to nitrogen and oxygen. This is called a reduction reaction. Converters that combine the oxidation of HC and CO with the reduction of NO_x are known as three-way converters. Three-way converters are even more sensitive to air-fuel ratio because their reduction of NO, is only efficient at stoichiometric air-fuel ratios.

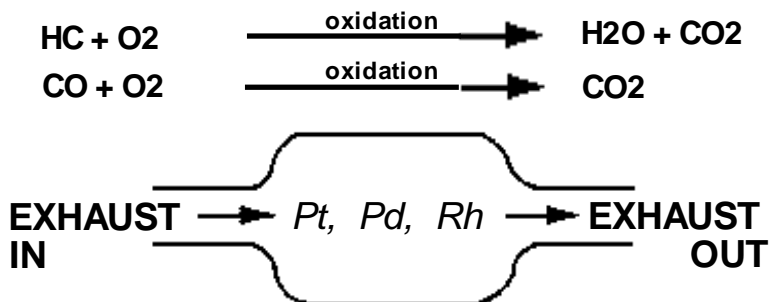

Figure 13 HC and CO Oxidation in a Catalytic Converter

Catalytic converters (both two- and three-way types) only lower HC, CO and NO_x by a certain amount. When the engine is operating properly, these emissions are low enough for the converter to decrease them to levels less than specified by state and federal regulations.

CATALYTIC CONVERTERS AND GAS ANALYSIS

Since catalytic converters lower HC and CO producing CO_2 and H_2O , monitoring HC and CO alone in catalytic converter-equipped vehicles does not give an accurate picture of engine/catalytic converter performance and operating efficiency. The analyzer monitors O_2 and CO_2 as well as HC and CO, so that all four exhaust products can be compared. This provides a more accurate representation of the operation of the engine and the catalytic converter.

USING ANALYZER READINGS FOR DIAGNOSIS

This exhaust analyzer is a highly versatile test instrument. In addition to testing carbon monoxide (CO), carbon dioxide (CO₂), oxygen (O₂), hydrocarbon (HC), and optionally oxides of nitrogen (NO_x) for emission control certification requirements or after a tune-up, it can be used to assist in detecting and locating ignition, fuel, exhaust, emission control and engine service problems.

There are a few general facts to keep in mind when using the analyzer:

1. High carbon monoxide (CO) readings usually indicate a fuel mixture richer than ideal. The amount of CO in a vehicle's exhaust is directly related to its air-fuel ratio. High CO levels result from inadequate O₂ supply needed for more complete combustion. This is caused by a mixture that is too rich, - too much fuel or not enough air.
2. High hydrocarbon (HC) readings usually indicate excessive unburned fuel caused by lack of ignition or by incomplete combustion. Common causes include a faulty ignition system, vacuum leaks, and fuel mixture problems.
3. High oxygen (O₂) readings indicate too lean an air-fuel ratio.
4. Low O₂ indicates a rich fuel mixture.
5. High carbon dioxide (CO₂) readings indicate a nearly ideal air-fuel ratio and efficient combustion.
6. Low CO₂ readings indicate a fuel mixture either too rich or too lean, exhaust system leaks, or analyzer sample dilution.
7. The byproducts of combustion are dependent on the air-fuel ratio.
8. O₂ combines with HC to form CO₂ and H₂O.
9. O₂ combines with CO to form CO₂.
10. CO is an indicator of richness.
11. HC is an indicator of leanness and misfires.
12. O₂ is a better indicator of leanness and misfires than HC.
13. CO and O₂ are equal at the stoichiometric air-fuel ratio.
14. O₂ and CO₂ are indicators of exhaust system integrity, sample hose and probe integrity, or both.
15. CO₂ is an indicator of combustion efficiency that peaks at or near the stoichiometric air-fuel ratios, and decreases with lean or rich air-fuel ratio.
16. Air injection systems dilute the exhaust sample with O₂.
17. O₂ is essential for proper operation of the catalytic converter. Its concentrations are essentially unchanged by the catalytic converter, providing a "window" through the catalytic converter to the engine. O₂ levels are higher on vehicles with properly operating air injection systems.
18. If CO goes up, O₂ goes down.
19. If O₂ goes up, CO goes down.
20. With the air injection system disabled and the CO above 1%, the catalytic converter is oxygen-starved. Without O₂, it does not fire, allowing exhaust concentrations to be more like readings taken ahead of the converter.

If readings are within the manufacturer's or local/state/ federal allowable limits, it can generally be assumed that the fuel, ignition, and emission control systems are functioning properly. If they exceed the limits, repairs or adjustments are probably needed.

The chart below lists some of the kinds of problems that could result in abnormal gas readings.

CO	CO ₂	HC	O ₂	Possible Problem(s)
H	L	H	H	Rich mixture with ignition misfire
H	L	H	L	Faulty thermostat or coolant sensor.
L	L	L	H	Exhaust leak after the converter.
L	H	L	H	Injector misfire, catalytic converter operating.
H	L	ML	L	Rich mixture.
H	H	H	H	Injector misfire, catalytic converter not working; combination of rich mixture and vacuum leak.
L	L	H	H	Ignition misfire; lean conditions; vacuum or air leak between airflow sensor and throttle body (false air).
L		H	L	Good combustion efficiency and catalytic converter action.
L		H	L	All systems operating within tolerance; normal reading.

Legend

L = low
M = moderate
H = high

The following table lists some of the results possible when the air-fuel ratio is sustained at conditions ranging from too lean to too rich.

Table 1 : Levels of Combustion Components and Tune-up Problems

CONDITION	RESULTS
Too Lean	Poor engine power Misfiring at cruising speeds Burned valves Burned pistons Scored cylinders Spark knock or ping
Slightly Lean	High gas mileage Low exhaust emissions Reduced engine power Slight tendency to knock or ping
Stoichiometric	Best all-around performance
Slightly Rich	Maximum engine power Higher emissions Higher fuel consumption Lower tendency to knock or ping
Too rich	Poor fuel mileage Misfiring Increased air pollution Oil contamination Black exhaust

Along with the use of other tools and equipment, the analyzer can be used as a diagnostic tool to help identify that a problem exists. This logical approach, along with other information and knowledge, will lead in a direction that will help to identify the most likely cause of the problem.

GENERAL TAILPIPE TESTING TIPS

1. Read and follow the maintenance and calibration procedures outlined in this manual.
2. Do not test exhaust emissions on vehicles that are smoking excessively or are in obvious need of engine repair. Testing exhaust gas under such conditions may contaminate the sampling system and cause inaccurate readings.
3. Keep the probe tip openings clean and free of debris.
4. Do not place the probe tip in liquids or allow liquids to be drawn into the analyzer's sampling system. If the sampling system is contaminated by any liquids, it will affect the accuracy of any future tests.
5. Do not place the probe in an exhaust pipe until the vehicle is at normal operating temperature. This allows the exhaust system time to burn off any residual moisture.
6. Test engines only when they are at normal operating temperature. Testing with a cold engine does not provide useful test results due to fuel mixture enrichment, and will contaminate the sampling filter quickly, requiring more frequent analyzer service intervals.
7. Never drive a vehicle over the probe, sample hose or power cord.
8. Perform the Leak Test periodically, especially after probe changes and filter service, to ensure accurate analysis.
9. Prolonged use of the analyzer in conjunction with a dynamometer and a hot-running vehicle under load could damage the exhaust probe hose and affect readings.
10. To comply with anti-tampering laws, always follow the manufacturer's specifications when working on emission control devices.
11. Always comply with the governing emission control standards and regulations in your locality when testing exhaust emission levels.
12. Check the manufacturer's specifications and procedures before testing a vehicle.
13. Before testing Tailpipe emission levels, maintain engine speed at about 2000 RPM for 30 seconds, followed by a 30-second normalization period at idle speed before reading gas values.
14. Leaks in the exhaust system will adversely affect readings and should be repaired prior to testing.
15. On vehicles with air injection systems, these systems should be disabled before some diagnostic tests. Denying the system this air results in undiluted gas samples and inhibits catalytic converter operation for more accurate diagnosis.
16. Insert the test probe fully into the tailpipe when testing exhaust emissions to prevent diluted readings.
17. On exhaust systems with twin tailpipes that exit a common resonator or muffler, the exhaust sample can be diluted from outside air entering the tailpipe outlets. To prevent this, block off the pipe not used for the sample probe.
18. On engines with fuel injection, tailpipe emission readings are only valid at idle speed. Testing at higher engine speeds is only valid when using a dynamometer. However, fuel injected engines should still be conditioned with the engine speed near 2000 RPM as recommended in TESTING TIP #14.
19. On V-type engines with only one oxygen sensor, a misfiring cylinder in one location may have more impact on the O₂ sensor than a cylinder in another location.

NOTE: Remember to remove the blocking device when testing is complete.

VEHICLE INSPECTION

EXHAUST SYSTEM INTEGRITY

1. Air management system - Ensure that check valves are not leaking.
2. Diverter valve/air switching valve - Ensure that valve is not sticking or leaking into closed off port.
3. Exhaust system pipes and connections - Check that connections are tight and there are no obvious leaks.

ENGINE LAMPS

Verify that the "Check Engine", "Service Engine Soon", or "Power Loss" lamp is functioning. Ensure that personnel have not removed the bulb.

BASIC ENGINE OTHER SERVICE FUNCTIONS

Check that engine timing, idle speed, fuel feedback system, vacuum wave form, cylinder time balance bar graph, cranking amps bar graph, etc., are normal for the vehicle being tested.

ELECTRICAL SYSTEM

Verify alternator operation and battery condition. AC voltage from the alternator can cause improper computer operation and cause miscalculation of fuel delivery and timing.

ENGINE CONDITIONING

Before testing tailpipe emission levels, engines should be at operating temperature.

1. Maintain engine speed at 2000 RPM for 30 seconds.
2. Drop engine speed to idle for 30 seconds.
3. Test the engine.

Some vehicles require special conditioning other than the procedure given here prior to testing idle emission levels. Failure to follow conditioning procedures will usually cause vehicles to fail state tailpipe emission tests even though all systems are operating as designed. For further assistance contact the state emission inspection program administrator.

CONNECTING PROBE HOSE TO SYSTEM

1. Connect the FGA 4000 Analyzer power cord into a standard 120 VAC, 50/60 Hz electrical receptacle (or 240 VAC, 50/60 Hz, for analyzer set up for that voltage).
2. Set the POWER switch on the front of the analyzer to ON.
3. The analyzer enters the Warm-up mode immediately.
4. Allow the analyzer to perform a complete Warm-up and Zero cycle. This may take up to fifteen minutes. The remaining steps may be completed during analyzer warm-up.
5. Connect the exhaust sample hose to the back of the analyzer at the filter assembly.
6. Wait until the analyzer indicates that it is in the STANDBY mode.
7. 30 minutes after the analyzer is in the STANDBY mode, insert the probe into the vehicle tailpipe, ensuring that the probe is fully inserted.
8. Press the START key.
9. Read the exhaust gas values on the displays.
10. Compare the values shown to:
11. All emissions standards.
12. The engine manufacturer's specifications.

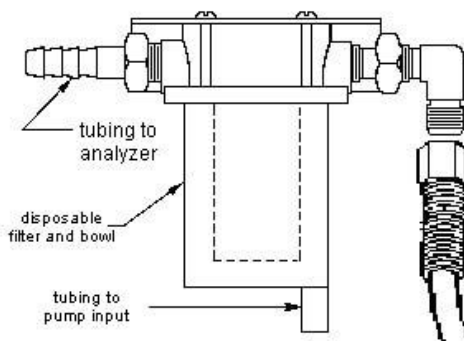

Figure 14 Connecting Probe Hose to System

NOTE: On vehicles with diffuser screens in the tailpipe, use the optional Anti-Dilution Probe).

INTERPRETATION

A fuel-injected engine that meets all of the above requirements may still have problems masked by the feedback fuel control system. Consult the vehicle maintenance schedule and perform the recommended service that may be required, including service on emission control devices.

If values exceed specifications and allowances, further diagnostic testing of the engine and exhaust system may be required.

Chapter 5 – Maintenance

The analyzer requires very little maintenance. The following chart itemizes the schedule for those items that do require periodic maintenance.

Component	Interval
Zero Vacuum Probe	Each Use
Sample System Hose	Check As Required
Filter	When a LOW FLOW indication appears*
Calibration	Check Every Three Months
Oxygen Sensor	Replace Every 1 to 2 Years depending on use
Nitric Oxide Sensor (Opt.)	Replace Every 1 to 2 Years depending on use. Requires calibration when replaced.

*Service filters more frequently if analyzer is operating continuously.

Checking and Cleaning the Probe

Periodically check the holes at the end of the probe for dirt and debris. Disconnect the hose from the analyzer at the sample inlet. Using a small pointed tool, clean the probe and blow away any debris, using compressed air.

CAUTION: DO NOT APPLY COMPRESSED AIR TO THE PROBE TIP WITHOUT DISCONNECTING THE SAMPLE HOSE FROM THE FILTER ASSEMBLY. BACK PRESSURE COULD DAMAGE THE SAMPLING SYSTEM.

REPLACING THE PROBE

1. Remove the sample probe from the handle.
2. Install the new probe on the handle and tighten. Use only Teflon tape on fittings.

SAMPLE HOSE

The sample hose must be free of cuts and abrasions that may cause leaks.

FILTER ASSEMBLY

The filter assembly uses a single filter and disposable bowl to keep the pump and internal sample system clean. The exhaust gas sample enters the filter from the sample hose. The filter element removes all the contaminants from the exhaust sample. Exhaust gas flows through this filter element from the inside out, so contaminants collect on the inside of the filter element. Also, water vapor contained in the sample gas condenses in the filter bowl where it is evacuated through the elbow fitting at the bottom of the filter bowl by the system pump.

SERVICING THE FILTER

Filter service frequency is dependent on the operating conditions. Continuous use, testing vehicles that have not been warmed-up to normal operating temperature, or testing engines that have excessive emissions will require more frequent filter service.

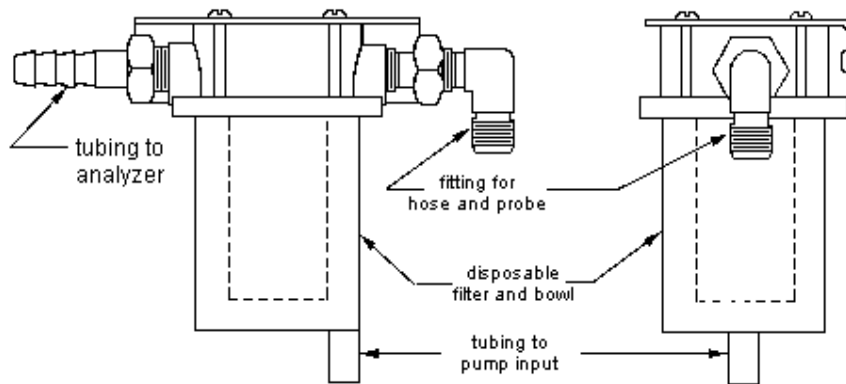

Figure 3: Filter Assemblies

The primary filter element is an unwoven, disposable material inside a disposable bowl. If debris builds up on the filter material, becomes discolored and the sample flow is reduced, the filter and bowl should be replaced.

1. Turn off power to the analyzer.
2. Remove the water drain tubing from the bottom of the filter bowl.
3. Remove the filter bowl by turning it counterclockwise.
4. Replace the old filter and bowl with a new one. Use only Summit part number 12-01-05028 as a replacement.

FRONT PANEL AND EXTERIOR

To maintain the appearance of the analyzer, periodically clean the exterior with a soft damp cloth. Use a mild detergent to remove grease.

CAUTION: DO NOT USE CLEANERS SUCH AS ACETONE, BENZENE, CARBON TETRACHLORIDE, GASOLINE, OR TOLUENE, AS THEY CAN DAMAGE PLASTIC COMPONENTS AND AFFECT ANALYZER ACCURACY IF THEY CONTAMINATE THE SAMPLING SYSTEM.

Gasoline, brake fluid, and penetrating oil spills should be immediately cleaned from the analyzer surface to protect its finish.

OXYGEN SENSOR

The oxygen sensor used in the analyzer requires replacement every 12 months. Several faults can be caused by an oxygen sensor defect, including:

- Zero Failure in the after a zero procedure (manual or automatic).
- General Failure. This may occur if the wire harness to the O₂ sensor is not connected.

NOTE: Once the shipping container can is opened, the sensor begins to deteriorate. Sensor life in open air is six months, regardless of how often the analyzer is used.

SERVICING THE OXYGEN SENSOR

1. Turn off the power to the analyzer.
2. Remove the oxygen sensor connector from the top of the sensor.
3. Remove the O₂ sensor from the top of the O₂/NO_x Transducer Manifold at the back of the analyzer. Turn the O₂ sensor counterclockwise (viewed from above) and remove it from the mounting block.
4. Install the new sensor in the mounting block. Turn the sensor clockwise (viewed from the top) into the mounting block until the O-ring is seated.
5. Install the sensor connector into the top of the sensor, ensuring it is connected correctly.

NOTE: *The connector is keyed so that it only plugs in correctly one way. Do not force the connector into the sensor.*

NOX SENSOR - OXIDE OF NITROGEN

The NO_x sensor used in the analyzer requires replacement every 12 months. Several faults can be caused by a NO_x sensors defect, including:

- Zero Failure in or after a zero procedure (manual or automatic).
- General Failure. This may occur if the wire harness to the NO_x sensor is not connected.

SERVICING THE NOX SENSOR

1. Turn off the power to the analyzer.
2. Remove the NO_x sensor connector from the top of the sensor.
3. Remove the NO_x sensor from the bottom of the O₂/NO_x Transducer Manifold at the back of the analyzer. Turn the NO_x sensor counterclockwise (viewed from below) and remove it from the manifold.
4. Install the new sensor in the mounting block.
5. Turn the sensor clockwise (viewed from the top) into the mounting block until the O-ring is seated.
6. Install the sensor connector into the top of the sensor, ensuring it is connected correctly.

NOTE: The connector is keyed so that it only plugs in correctly one way. **Do not** force the connector into the sensor.

ROUTINE CLEANING

The analyzer should be cleaned routinely to prevent the buildup of dirt, which can contaminate samples and mar the appearance of the instrument. Clean the case exterior and other accessible parts of the analyzer with a cloth dampened with warm water and mild soap.

RETURNING THE ANALYZER FOR SERVICE/REPAIRS

If the analyzer needs service, contact your dealer for complete instructions. If you need to ship the analyzer, pack it in its original container. We recommend that you insure the shipment.

To help in getting effective service, follow these guidelines:

1. Follow all instructions in this manual to be sure that the problem is with the analyzer and not with other equipment, sample purity, or cable connections.
2. If you determine that repair is required, contact the factory to receive a Return Materials Authorization (RMA) number. This is required prior to sending the unit in for repair. Also, be sure to include the following items when returning the analyzer for service:
3. A description of the precise sample and operating circumstances.
4. A brief description of the symptoms.
5. The serial number.
6. Your name, address, and telephone number.

Before purchasing and using this analyzer, the user should determine the suitability of the product for his or her intended use and, the user assumes all risks and liabilities whatsoever in connection therewith.

If a product malfunction should occur, you may contact the seller or the manufacturer at::

Infrared Industries, Inc.
25590 Seaboard Lane
Hayward, Ca. 94545
Voice: 510-782-8100 or 800-344-0321
E-mail: service@infraredindustries.com

If it is necessary to return the analyzer, notify the seller in your area or contact Infrared Industries at the address/phone number above. You must obtain a RMA number before sending in the unit. Note the RMA number on the outside of the box. Package the instrument carefully and securely. **Do not** ship the instrument with any accessories or power cords in the box. Please include a written description of any observation of the malfunction, along with the return ship to address and your contact phone/fax number. Then proceed to ship the instrument with freight prepaid to the address above.

Chapter 6 – Troubleshooting

ANALYZER TROUBLESHOOTING

There are three failure modes that the analyzer might encounter: General Failure, Zero Failure, and Failure to Calibrate.

For a General Failure and Zero Failure, perform the following procedure:

1. Verify that all the back panel ports are unobstructed, including:
 - Cal gas
 - Zero
 - Sample hose
 - Drain hose
 - Cal gas
 - Zero
 - Sample hose
 - Drain hose
2. Verify that the O₂ sensor wire harness is properly connected to the top of the sensor.
3. Replace the O₂ sensor if it has been installed for more than six months, or if its age is unknown.
4. Check the filters.
5. If a failure is still indicated, service is required by an authorized Summit Analyzer service center.

For a Failure to Calibrate, perform the following procedure:

1. Repeat calibration.
2. If the analyzer still fails to be calibrated, the analyzer can still be used but it will be at reduced accuracy. It should be sent in for service when convenient.

When the default cal values are in use, the analyzer can still be used but the displayed values will be less accurate. It is recommended that the gas calibration procedure be performed to ensure accuracy.

SYMPTOM	PROBABLE CAUSE	SOLUTION
Low sample flow	<ol style="list-style-type: none">1. Restrictions in sample hose or probe.2. Restrictions in sample filter.	<ol style="list-style-type: none">1. Check for kinked, plugged or pinched hose or probe. Clean probe tip with a small pointed tool. Disconnect hose from sample inlet and blow out if necessary.2. Service filter elements.
Low sample flow during zeroing.	Restriction in Zero port.	Check for obstructions in zero port on the back of the analyzer. (Zero port is under the CAL port.)
All function keys inoperative.	Microprocessor latch-up.	Turn analyzer power switch OFF and then back ON.

Appendix A – Lambda Calculations

BRETTSCHNEIDER EQUATION

In order to calculate the value of Lambda from measurements of combustion by products in the exhaust of a gasoline engine, a mathematical model is necessary. This model must include consideration for the chemical make-up of the fuel being burned and many other factors. The model is complicated and the derivation of the equation, beyond the scope of this manual. We will merely site the equation used by the system and the assumptions that were used in implementing it. The equation used in the system is the one derived from a model created by Prof. Brettschneider. It is commonly referred to in the industry as Brettschneider's λ Equation. It is shown below.

$$\lambda = A*[B-C]$$

where:

$$A = \frac{21}{21 + 50ux\{(CO/CO_2)/(K+[CO/CO_2])\}}$$

In the equation for **A** the term "x" is the mass ratio of water in air even at a relative humidity of 100% this term is very small. As "x" becomes small **A** approaches 1. **A** is assumed to be 1 in the system's calculations.

B =

$$\frac{\{CO_2+[CO/2]+[NO_x/2]+O_2\} + \{[H_{cv}/4]*[K/(K+[CO/CO_2])]-[O_{cv}/2]\}*[CO+CO_2]}{\{1+[H_{cv}/4]-[O_{cv}/2]\}\{CO+CO_2+HC\}}$$

In the equation for **B**

H_{cv} is the Hydrogen to Carbon Ratio of the fuel. The default value for H_{cv} is 1.8

O_{cv} is the Oxygen to Carbon Ratio of the fuel. The default value for O_{cv} is 0 (assume no oxygenated fuels)

K = 3.5 = the water gas constant of combustion

C =

$$\frac{\{W_{cv}/2\} \{[CO/CO_2]/(K+[CO/CO_2])\} \{CO+CO_2+HC\}}{\{1+[H_{cv}/4]-[O_{cv}/2]\} \{CO+CO_2+HC\}}$$

In the equation for **C** W_{cv} is the Water Fraction of the fuel.

Because A = 1, the equation for Lambda becomes:

$$\lambda = B-C$$

Note: H_{cv} and O_{cv} affect how the gasoline composition changes the calculation of Lambda. Normal gasoline is only hydrogen and carbon and therefore the default values that the factory puts in for H_{cv} is 1.8 and for O_{cv} is 0. However when oxygenates are added to the fuel (as required by law in some locations) these parameters should be changed. The operator can do this in STANDBY mode.

Appendix B – DAC Outputs

This gas analyzer supports eight DAC output channels: Each Channel is defined as follows:

Pin	Description	Range 0 – 1, 5, 10V
1	HC	0 – 9999 PPM
2	CO	0 – 10%
3	CO2	0 – 20%
4	O2	0 – 25%
5	NOx (if applicable)	0 – 5000 PPM
6	Lambda	0 – 5
7	TACH	0 - 9999 RPM
8	Air Fuel Ratio (AFR)	0 - 50
9	Ground	

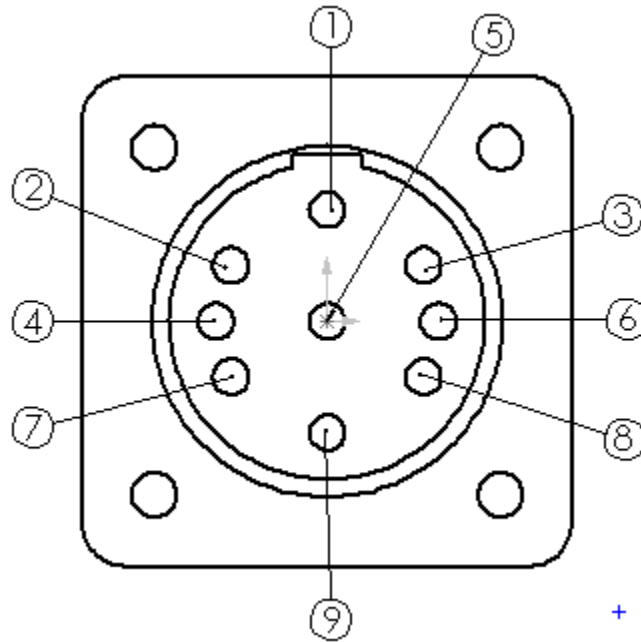

During a GPM Test, the DAC Outputs are expressed as follows:

Pin	Description	Range 0 – 1, 5, 10V
1	HC	0 – 10 Grams Per Second
2	CO	0 – 50 GPS
3	CO2	0 – 50 GPS
4	O2	0 – 25 GPS
5	NOx (if applicable)	0 – 5 GPS
6	Lambda	0 – 5
7	TACH	0 - 9999 RPM
8	Air Fuel Ratio (AFR)	0 - 50
9	Ground	

Appendix C – OBDII Option

The gas analyzer has an optional feature to read the tachometer value from an OBDII scanner. To use this feature you must have an adapter and scanner from Infrared Industries. The adapter plugs into the serial connector on the back of the analyzer. Each adapter is configured to be paired to a specific OBDII Bluetooth scanner. ***Make sure the labels on the adapter and scanner match when using this feature.***

When using this feature the Serial Port configuration must be set to **obd2**. See Chapter 1 on how to configure the serial port.

To use this feature:

- The Serial Port configuration must be set to **obd2**. See Chapter 1 on how to configure the serial port.
- Connect the serial adapter to the back of the analyzer.
- Plug the OBDII scanner into the vehicle.
- When the vehicle is turned on the RPM values will be displayed on the analyzer. (Make sure the display is configured to show RPM values). If you do not see the values go into the Menu on the analyzer and check the serial port setting.
- If a tachometer cable is plugged into the analyzer at the same time as the serial adapter then the analyzer will show the readings from the tachometer cable and not the OBDII.

Appendix D - Specifications

The following specifications are subject to change without notice:

PRINCIPAL GASES/RANGES MEASURED

HC, CO, CO ₂	Non-Dispersive Infrared (NDIR)
O ₂ , and NO _x	Chemical Cell
CO, carbon monoxide.....	Range 0 to 10.00%
HC, as n-hexane.....	Range 0 to 10,000ppm
CO ₂ , carbon dioxide.....	Range 0 to 20%
O ₂ , oxygen.....	Range 0 to 25%
NO _x , Nitric Oxide (Option).....	Range 0 to 4,000ppm

Operating Temperature:.....	2°C to 40°C [35.6°F to 104°F]
Storage Temperature:.....	-40°C to +75°C [-40°F to 167°F]
Power:.....	120 / 240 VAC, +/- 10%, 50/60 Hz,
Weight.....	12.5 Lb.
Size:.....	18.5 cm high, 29.5 cm wide, 43.5 cm length [7.3 in. high, 11.5 in. wide, 17 in. length]
Displays:.....	18mm high digits, 4-digit LED's

OUTPUT DATA INTERFACE:

Digital:.....	RS-232C
Altitude:.....	-300m to +1000m [980 ft. to 3300 ft.]

Appendix E – Warranty

NOTICE TO BUYER AND/OR USER OF THE ANALYZER:

Exclusion of warranties and limitation of damages and remedies

This analyzer is warranted against defects in materials and workmanship under normal use and service for one year from the date of delivery to the original purchaser.

The sole obligation of the seller and/or manufacturer under this warranty is limited to repairing or replacing as the seller or manufacturer may elect, free of charge at the place of business of the seller or manufacturer, any parts that prove, in the seller or manufacturers judgment, to be defective in materials or workmanship within one year after delivery to the original purchaser.

This warranty shall not apply and is void if, in the opinion of the seller and/or manufacturer, the portable analyzer or any component thereof has been damaged by accident, other causes not arising out of defects in materials or workmanship.

WARRANTY EXCLUSIONS

THIS WARRANTY AND THE SELLER AND/OR MANUFACTURER'S OBLIGATION HEREUNDER IS IN LIEU OF ALL OTHER WARRANTIES, EXPRESSED OR IMPLIED, INCLUDING WITHOUT LIMITATION, THE WARRANTIES OF MERCHANTABILITY AND FITNESS FOR A PARTICULAR PURPOSE, AND ALL OTHER REPRESENTATIONS CONCERNING THE SALE, USE AND/OR PERFORMANCE OF THE ANALYZER.

No person is authorized to give any other warranties or to assume any other liability on behalf of the seller or manufacturer. This warranty shall not be extended, altered or varied except by written agreement signed by the seller and the buyer.

LIMITATION OF DAMAGES

IN NO EVENT SHALL THE MANUFACTURER OR SELLER OF THE PORTABLE ANALYZER BE LIABLE FOR ANY INCIDENTAL OR CONSEQUENTIAL DAMAGES ARISING OUT OF OR IN CONNECTION WITH ANY OBLIGATION IMPOSED UPON THE SELLER OR MANUFACTURER IN CONNECTION WITH THIS WARRANTY. SUCH INCIDENTAL AND CONSEQUENTIAL DAMAGES SHALL INCLUDE, WITHOUT LIMITATION, LOSS OF USE, LOSS OF INCOME, LOSS OF PROFIT (INCLUDING LOSSES TO BUSINESS INTERRUPTION), LOSSES SUSTAINED AS THE RESULT OF INJURY (INCLUDING DEATH) TO ANY PERSON, AND LOSS OF OR DAMAGE TO PROPERTY. THE LIABILITY OF THE SELLER AND/OR MANUFACTURER ON THIS WARRANTY IS LIMITED TO ACCEPTING RETURN OF THE PORTABLE ANALYZER, REFUNDING ANY AMOUNT PAID THEREON AND CANCELING ANY BALANCE STILL OWING ON THE EQUIPMENT. THIS REMEDY IS EXCLUSIVE-REPAIR OR REPLACEMENT PROCEDURE

Appendix F – Glossary of Terms

This glossary defines terms used throughout the manual.

Air-Fuel Ratio (AFR) – The ratio by volume of air to vaporized fuel in the combustion chamber of an engine. It is usually expressed as the amount of air to one part of fuel. For example the ideal mixture for most fuels is 14.7 parts of air to one part of fuel. This would be written as the ratio 14.7 to 1 or an AFR of 14.7:1. The smaller the quantity of air, the richer the fuel mixture - the larger the quantity of air, the leaner the mixture.

Display - The light emitting diode (LED) digital display where gas concentrations and calculated results are displayed.

Indicator – Small LEDs that are on the front panel. These devices are lit when the system is in the state the device represents.

Function - A distinct operation of the analyzer.

Function Key - A push-button that initiates functions in the various analyzer modes of operation.

Lean Mixture - An air-fuel mixture containing less than the ideal amount of fuel.

LED - Light Emitting Diodes used in the displays.

Lambda (λ) - A parameter that expresses air-fuel ratio. Lambda is the ratio of the measured air fuel ration to the ideal or most efficient air fuel ratio as shown below.

$$\lambda = \text{AFR}_{\text{measured}} / 14.67$$

When AFR is displayed as Lambda a value of 1.0 represents the ideal air-fuel mixture of 14.67:1. Values of Lambda greater than 1.0 such as 1.3, represent a lean mixture. Values of Lambda smaller than one, such as 0.85 represent a rich mixture.

Mode – An operational state for the system such as warm-up or standby.

Rich Mixture -An air-fuel mixture containing more than the ideal amount of fuel.

Stoichiometric - Describes the ideal air-fuel ratio.

Tail Pipe - The vehicle's exhaust port.

